

ICAS

P H A R M A C Y D R A W E R S

TAXIS PLUS



INDICE

Index

■ TAXIS PLUS	p.	2
■ ESTRAZIONE 100%	p.	4
■ INFORMAZIONI TECNICHE	p.	8
■ STRUTTURE	p.	10

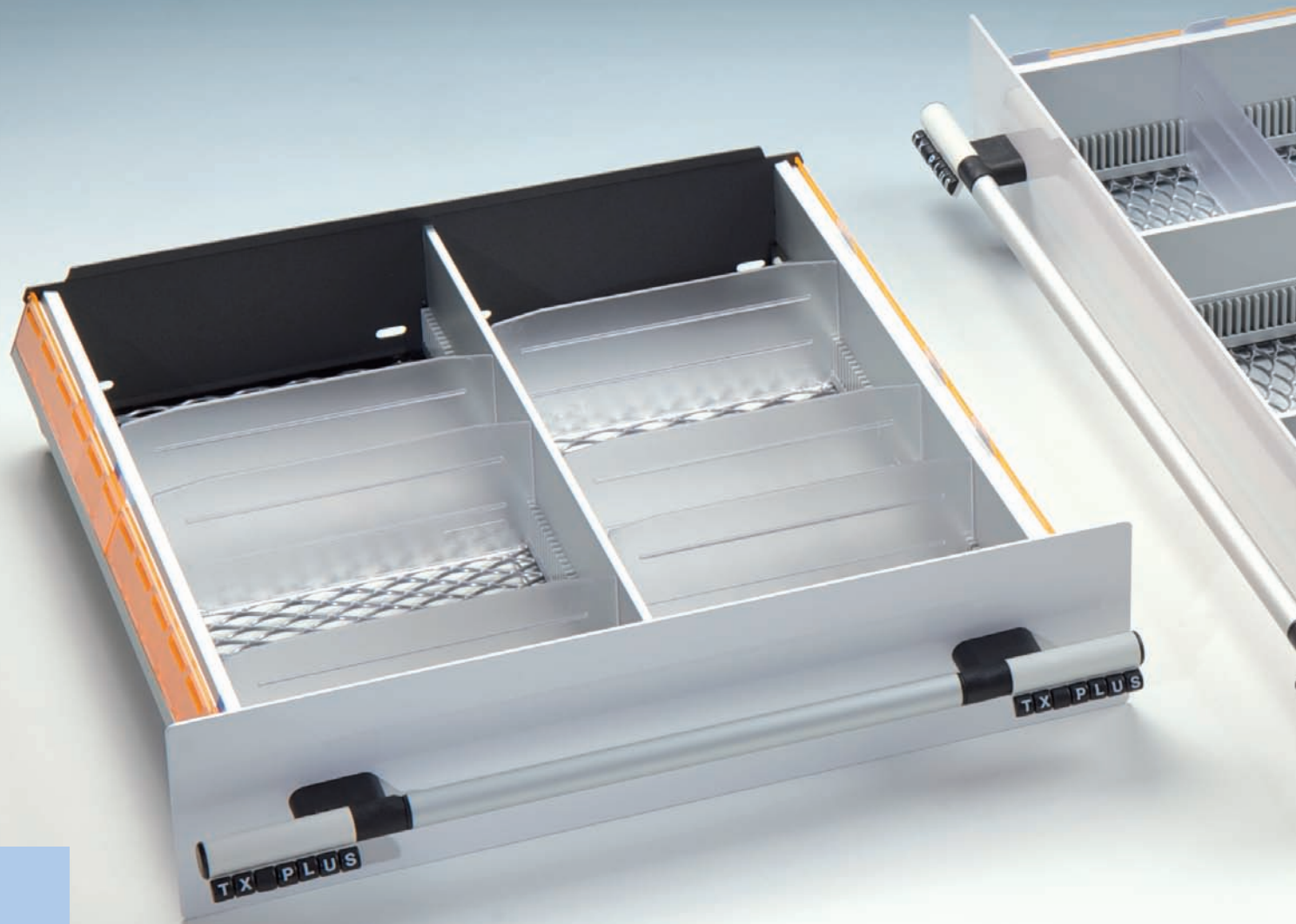

TAXIS Plus

Nessun altro cassetto per farmacia è innovativo come l'ultimo prodotto della Icas. **TAXIS PLUS** raccoglie e consolida l'eredità degli ultimi 20 anni della serie Taxis 1 e Taxis 2. **TAXIS PLUS** è il primo cassetto ad avere il fianco con incorporato un portasciade in materiale plastico che facilita l'identificazione dei prodotti. Unico nel suo settore, il nuovo sistema brevettato offre una capacità di contenimento del 100% garantendo una maggiore portata. Disponibile in sei profondità e cinque larghezze, **TAXIS PLUS** è l'evoluzione naturale di un grande progetto.

No other drawer for pharmacy is so innovative as Icas new product. TAXIS PLUS consolidates and collects last 20 years heritage of Taxis 1 and Taxis 2 drawer. TAXIS PLUS is the only drawer having plastic card holder integrated in the side, making it easy to identify all the products. Unique in its field, this patented system, offers a 100% capacity. TAXIS PLUS is available in 6 depths and 5 widths and it is the natural evolution of a big project.



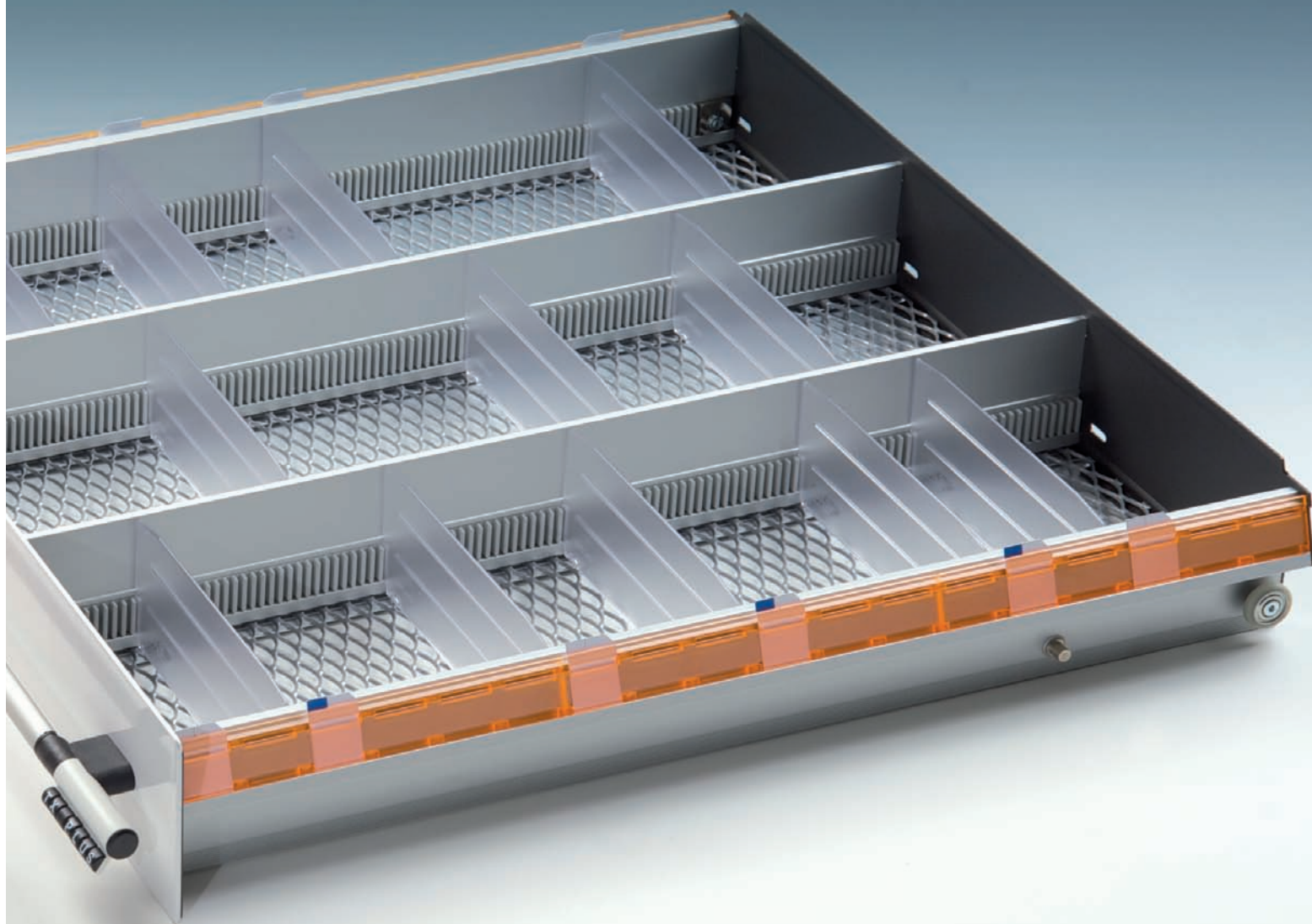

Aucun autre tiroir pour la pharmacie est si innovateur que le dernier produit de Icas. TAXIS PLUS rassemble et consolide l'héritage des 20 dernières années de la série Taxis 1 et Taxis 2. TAXIS PLUS est le premier tiroir avec un porte-étiquette en plastique déjà incorporé dans le coté, afin de faciliter l'identification des produits. Unique dans son domaine, le nouveau système breveté, a une capacité de 100% et permet ainsi une charge plus grande. Disponible en six profondeurs et cinq largeurs, TAXIS PLUS est l'aboutissement naturel de nos recherches.

Keine andere Schublade für Apotheken ist so innovativ wie das letzte Produkt von Icas. TAXIS PLUS umfasst und konsolidiert das Erbe der letzten 20 Jahre der Serien Taxis 1 und Taxis 2. TAXIS PLUS ist die erste Schublade, in deren Seitenteil eine Kartentasche aus Plastikmaterial integriert ist, der die Produktidentifikation vereinfacht. Das neue patentierte System ist in seinem Bereich einzigartig, bietet eine Aufnahmekapazität von 100% und gewährleistet so ein höheres Fassungsvermögen. TAXIS PLUS ist in sechs Tiefen und fünf Breiten erhältlich und stellt die natürliche Weiterentwicklung eines großen Programms dar.

Ningún otro cajón para farmacia es tan innovador como el último producto de Icas. TAXIS PLUS reúne y afianza el legado de los últimos 20 años de las series Taxis 1 y Taxis 2. TAXIS PLUS es el primer cajón que tiene el lateral con un portafichas incorporado de material plástico que facilita la identificación de los productos. Único en el sector, el nuevo sistema patentado permite aprovechar el espacio al máximo, garantizando una mayor capacidad. Disponible en seis profundidades y cinco anchos, TAXIS PLUS es la evolución natural de un gran programa.

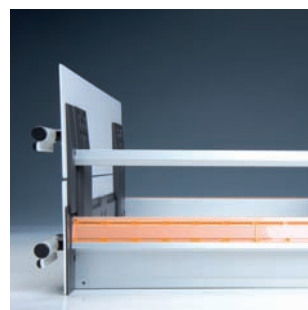
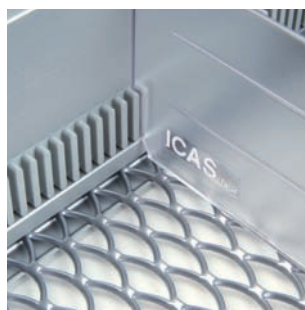
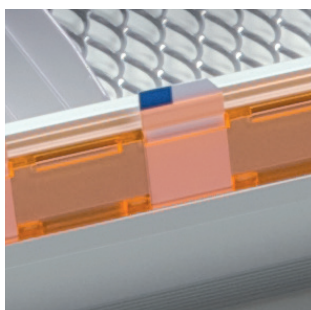





3
 pulizia

4
 portata

5
 portaschede integrato

2
 spazio 100%

1
 vasta gamma separatori



6
 guida telescopica brevettata

1 Wide range of dividers
 Série complète de séparations
 Viele Querteiler
 Dilatada gama de separadores

2 100% space
 Espace 100%
 100% Platz
 100% de espacio

3 Cleanness
 Propreté
 Sauberkeit
 Limpieza

4 Capacity
 Capacité
 Aufnahmekapazität
 Capacidad

5 Integrated card holder
 Porte étiquette intégrée
 Integrierte Kartentaschen
 Portafichas integrado

6 Patented telescopic runner
 Coulisse télescopique brevetée
 Patentierte Teleskopische Schienen
 Guía telescópica patentada

10.000 prodotti a portata di mano



10.000 close at hand products • 10.000 produits sous la main • 10.000

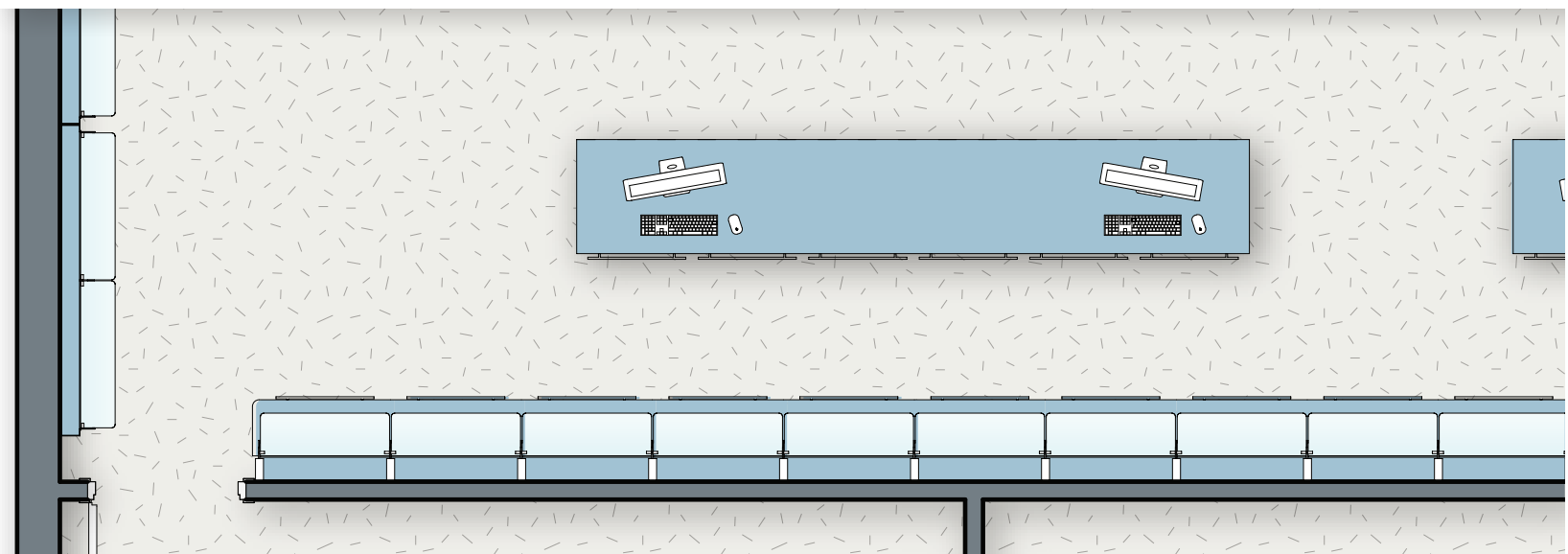



10.000 Produkte bei der Hand • 10.000 productos al alcance de la mano

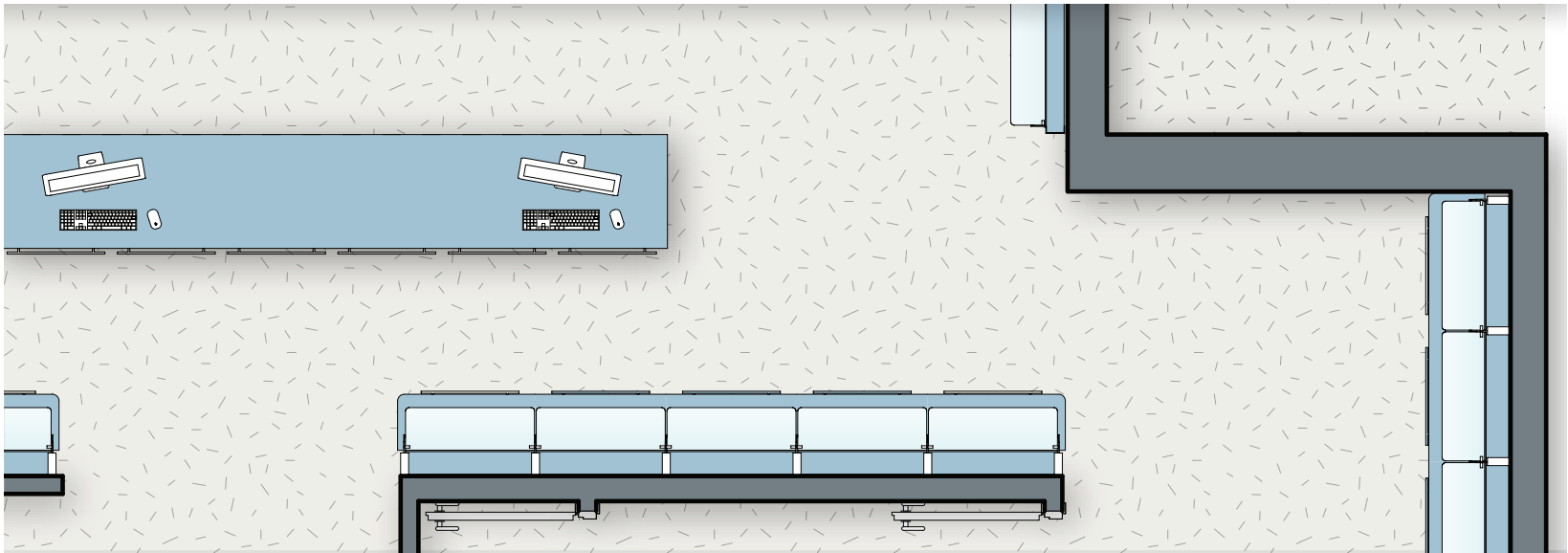

Informazioni tecniche

Technical information • Information techniques • Technische Informationen • Informaciones técnicas

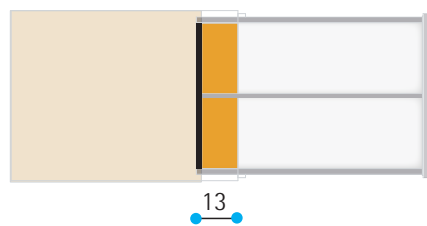
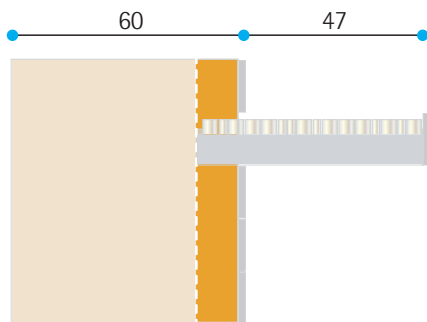

Cassetto tradizionale
Normal drawer
Tiroir classique
Normal Schublade
Cajón tradicional

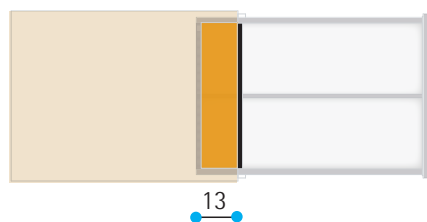
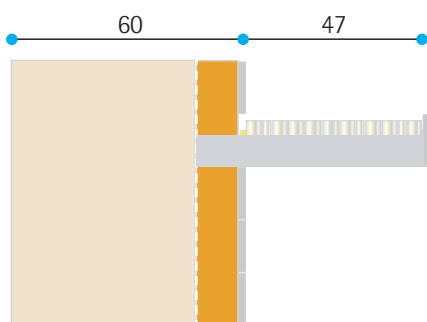

Cassetto per farmacia
Conventional pharmacy drawer
Tiroir standard pour pharmacie
Standard Schublade für Apotheke
Cajón para farmacia

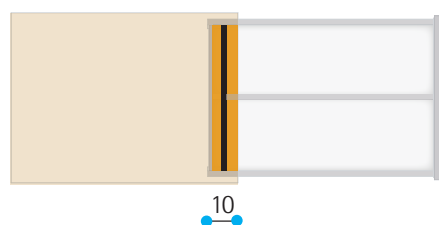
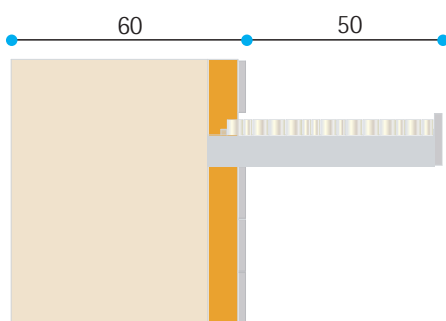

Cassetto semi telescopico
Semi telescopic drawer
Tiroir semi-télescopique
Halbe-teleskopische Schublade
Cajón semi-telescópico

Perdita • Lost Perte • Verlust • Pérdida de espacio



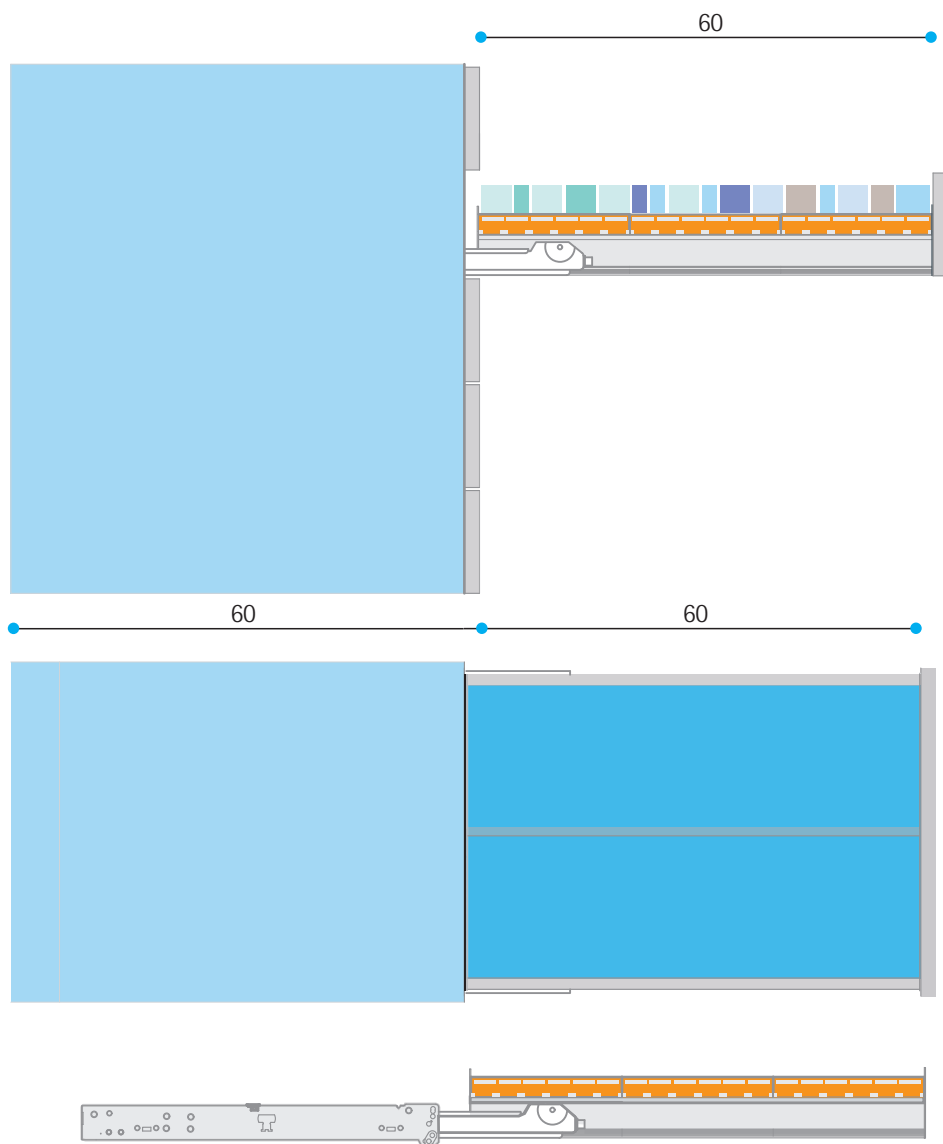

TAXIS PLUS
 cassetto telescopico
Fully telescopic drawer
Tiroir télescopique
Teleskopische Schublade
Cajón telescópico

Cassetto tradizionale
Normal drawer
Tiroir classique
Normal Schublade
Cajón tradicional

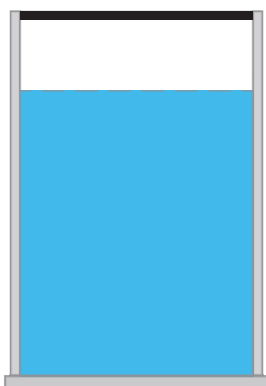

Cassetto per farmacia
Conventional pharmacy drawer
Tiroir standard pour pharmacie
Standard Schublade für Apotheke
Cajón para farmacia

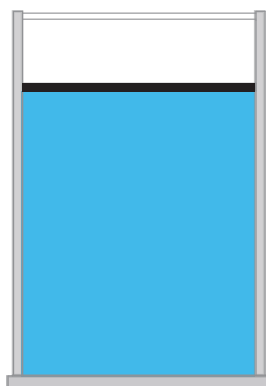

Cassetto semi telescopico
Semi telescopic drawer
Tiroir semi-télescopique
Halbe-teleskopische Schublade
Cajón semi-telescópico

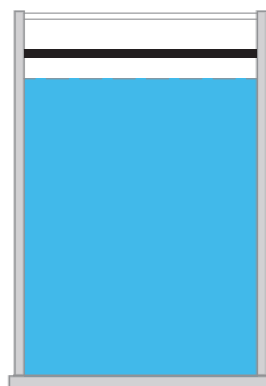

TAXIS PLUS

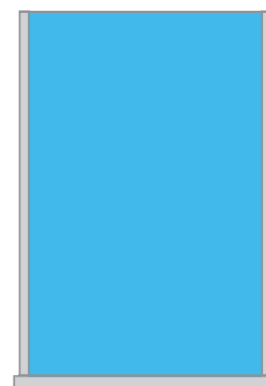

Spazio disponibile • Available space • Espace disponible • Verfügbar Platz • Espacio disponible



TiAXIS Plus Un'infinità di cassetti

An infinity of drawers • Une infinité de tiroirs • Eine Unzahl Schubladen • Una infinidad de cajones

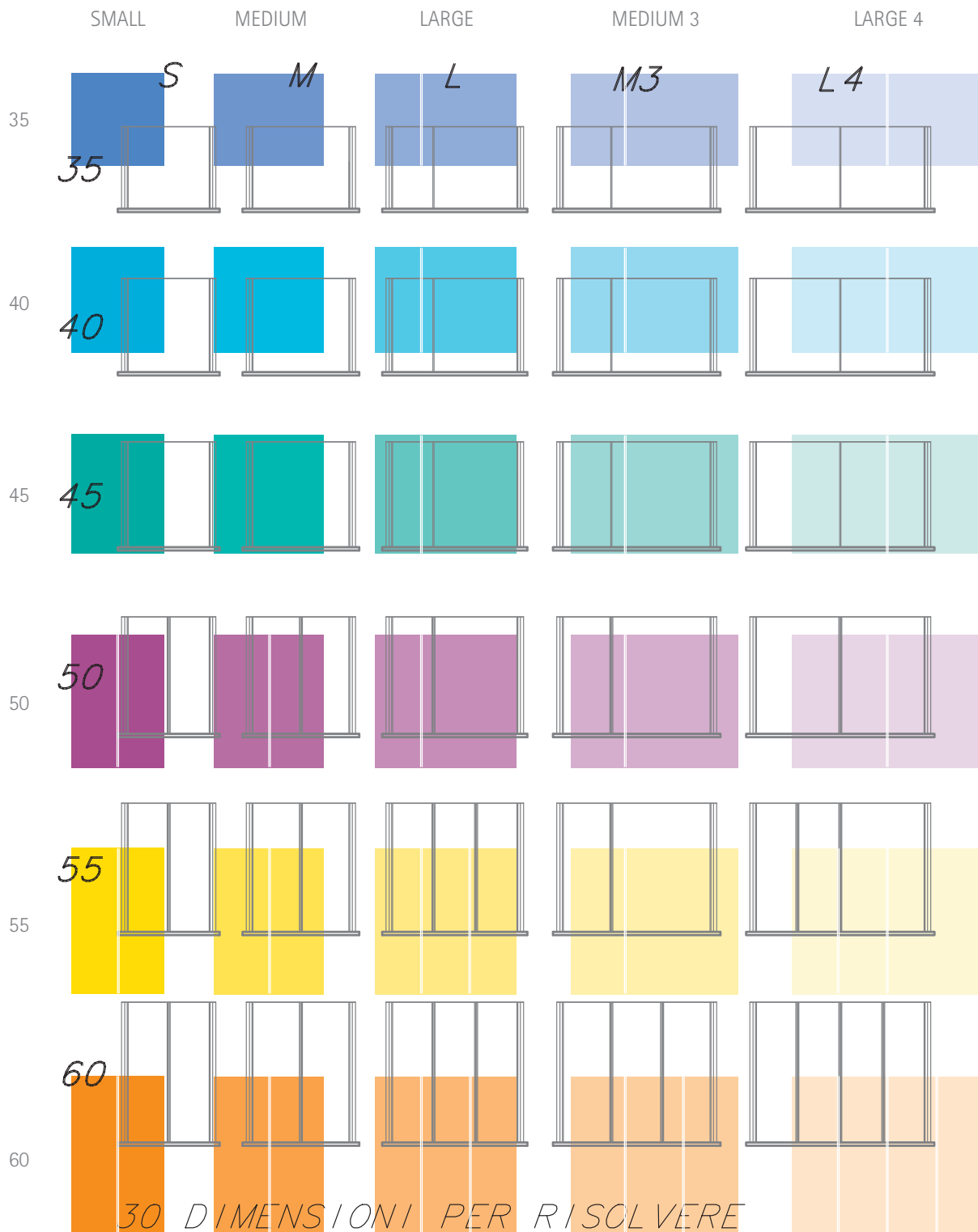

30 Dimensionen um alle Platzprobleme zu lösen
30 Medidas para resolver los problemas de espacio

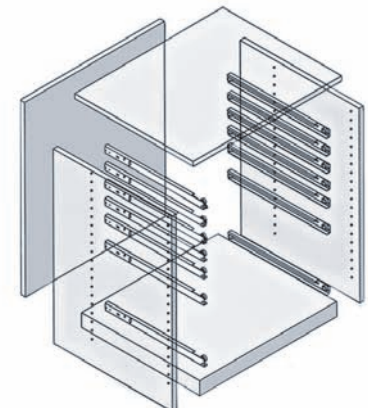
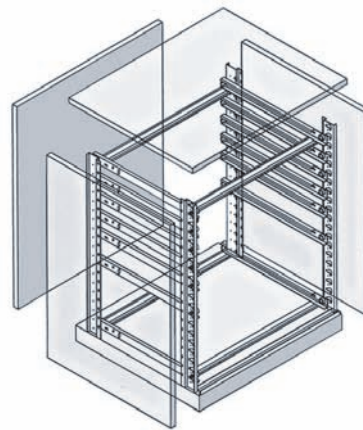
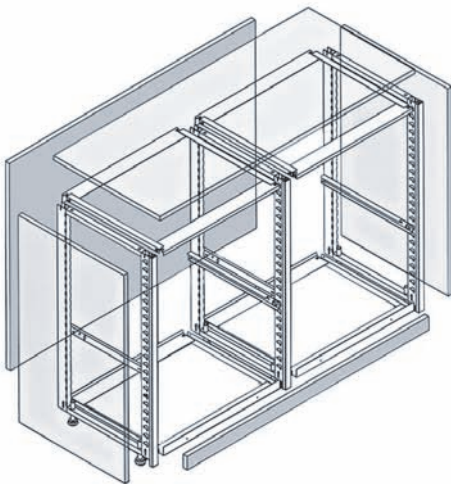
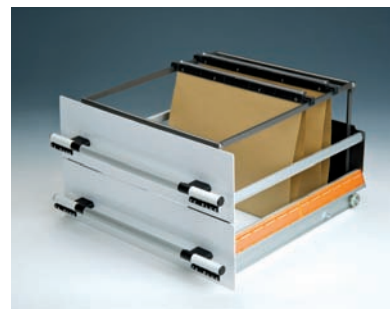
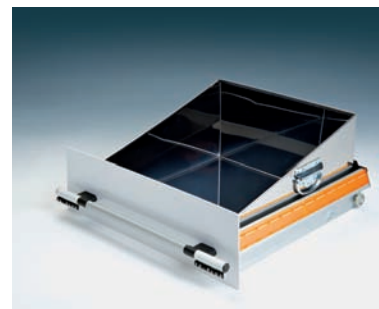
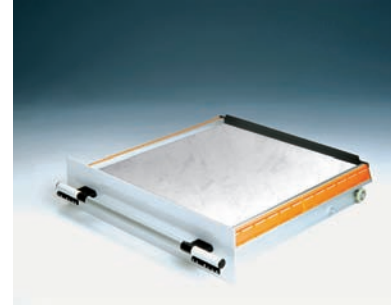

Struttura autoportante
Self-supporting structure
 Structure autoportante
 Selbsttragende Struktur
 Estructura autoportante

Struttura ad incasso
Built-in structure
 Structure à encastrer
 Struktur zum einfassen
 Estructura de encastre

Cassetto con guide da avvitare
Drawer with runners to be screwed
 Tiroir avec coulisses à visser
 Schublade mit Führungsschienen
 Cajon con guías a atornillar

TAXIS Frontali

Fronts • Façades • Frontladen • Frontes

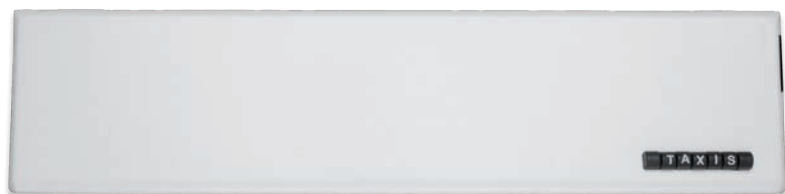

ABS



Daphne



Inox



Nas





100% estraibile Massima visibilità

100% full extraction
Total visibility

Extraction totale
Visibilité totale

100% ausziehbar
Optimale Sicht

Completamente estraibile
Máxima visibilidad



ICAS è la prima azienda produttrice di cassettiere e complementi d'arredo ad ottenere il Certificato ISO9001 per l'intera azienda, da parte dell'Associazione Svizzera per sistemi di Qualità e Management (SQS).

ICAS has been one of the first Companies producing drawers and components for pharmacy to attain the certification of quality control ISO9001, awarded by the Swiss Quality Systems and Management association (SQS).

ICAS a été une des premières sociétés productrices de colonnes tiroirs et accessoires pour pharmacie à se servir de la certification pour le contrôle de la qualité ISO9001 donné par l'Association Suisse pour les Systèmes de Qualité et Management (SQS).

ICAS war eines der ersten Unternehmen, welches sich der Qualitätskontrolle nach ISO9001 für das gesamte Unternehmen seitens der Schweizer Vereinigung für Qualitätssysteme und -management (SQS).

ICAS ha sido una de las primeras firmas que ha conseguido la certificación para el control de calidad ISO9001 para toda la empresa por parte de la Asociación Suiza para Sistemas de Calidad y Management (SQS).



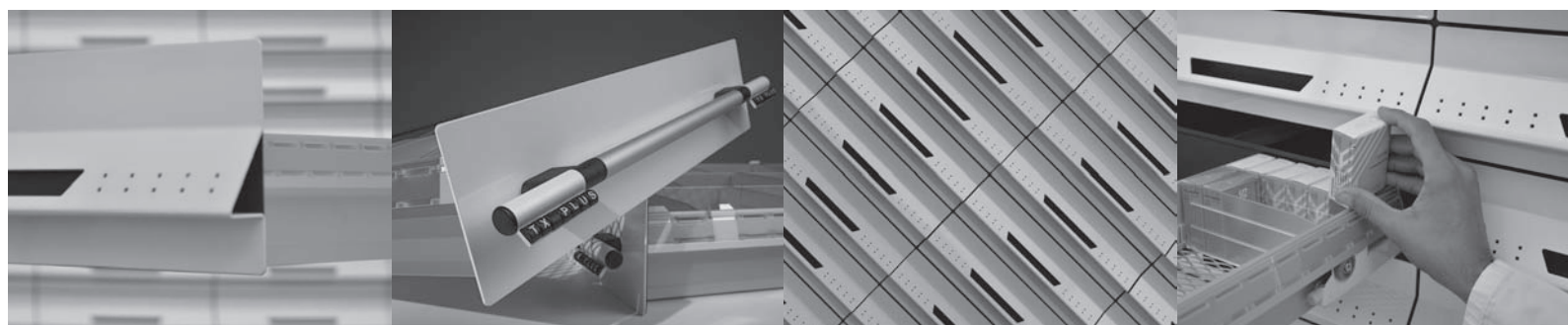

ICAS S.R.L. S.S. 415 Km 28,650 26010
Vaiano Cremasco (Cremona) Italy
Tel. +39 0373 278045 Fax +39 0373 278107
web site www.icas.it e-mail comm@icas.it

ICAS